

QUALITY CREATES IT'S OWN DEMAND

RACE FISH PLAY

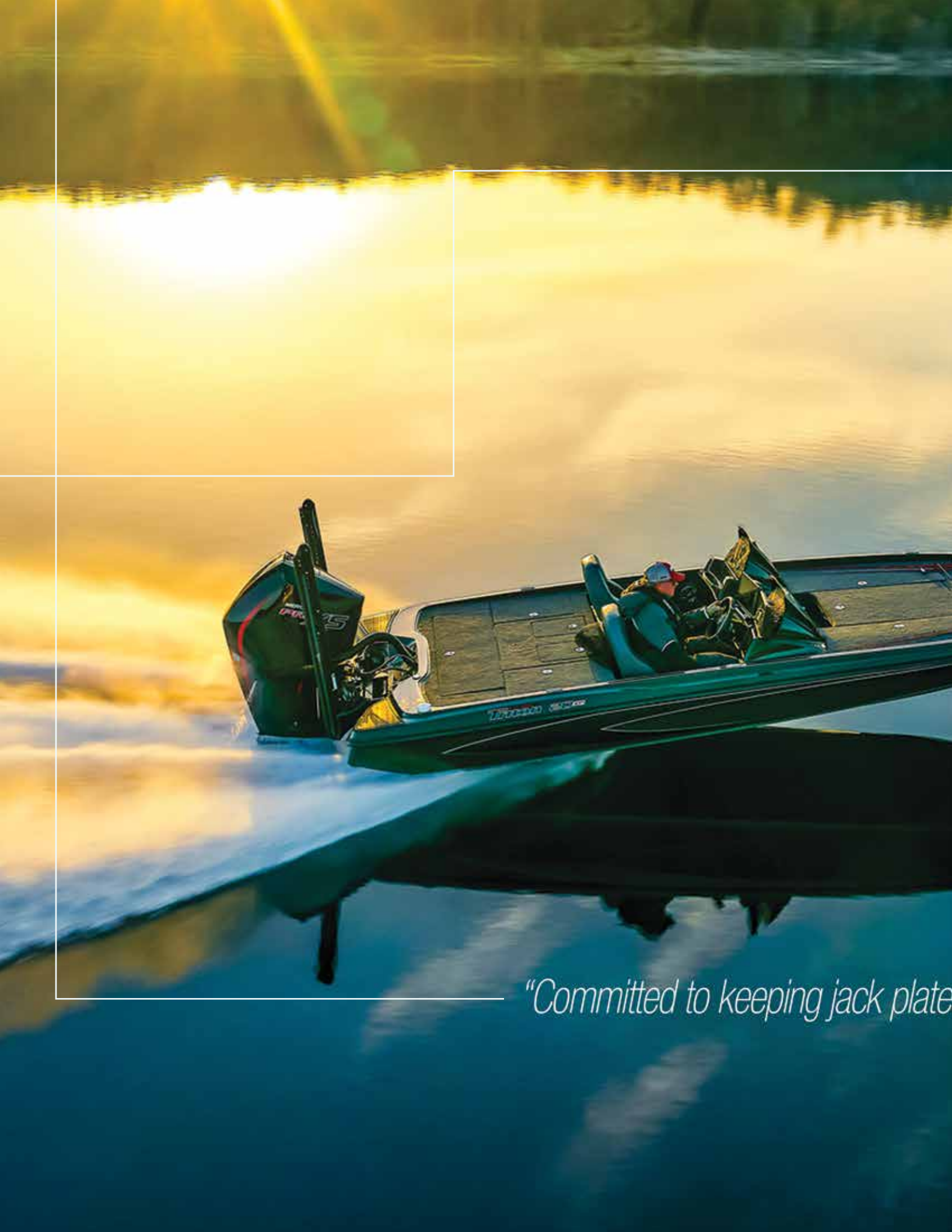

**2024
CATOLOG**



"Committed to keeping jack plate



Jack Plates are our business.

Since 1978, Bob's Machine has brought innovation to the jack plate market. The first to offer multiple setbacks. The first to offer color options. At Bob's, jack plates aren't just one of our lines of products. They are our main line.

We want nothing more than the best boating experience possible.

We're committed to providing you with the highest level of service, so you'll always choose us for your jack plates and outboard accessory needs.

Whether you are an OEM boat builder or just a weekend fisherman, our customer service and tech staff will work as hard as possible to get you setup right! 



s made in the USA"



See our USA facility!

ACTION SERIES JAC™ PLATES



**MADE IN THE
USA** 

Bob's Machine Shop's new hydraulic jack plate line, "Action Series Jac™ Plate", offers new technology in the Jack Plate market. The first Bob's Jack plate to offer a pump inside the jack plate structure, saving boaters room inside the boat, and eliminating the need to mount a pump inside the boat. This is a great OEM feature to help save time in rigging.

The new internal pump has a motor stronger than any other internal jack plate on the market currently, which will offer greater lifting speed, and strength with heavy outboards. All of the Bob's patented features from our standard series, automotive style grease nipples in the side rails, tension rods, and the famous Bob's Machine Shop Design, are all incorporated into the Action Series Jac™ Plate.

Offered in 4", 6", 8", 10", 12" and 14" setbacks, Bob's Jack plates offer 1 piece design, unlike competitors that require setback spacers to achieve the proper setback.



ACTION SERIES JAC™ PLATES

BobsMachine.com
813.247.7040

MADE IN THE USA - LIFETIME WARRANTY - 5 YEAR PUMP WARRANTY

ACTION SERIES FEATURES & BENEFITS

- Internal pump mounted inside plate for easier rigging
- One piece jack plate - No C-Channels to bolt on to increase setback
- Large powerful motor that can lift heavy outboards under full power in 6 seconds
- Can be converted to have pump inside the boat if the owner desires to change style of hydraulic pump
- Predrilled for side mount shallow water anchors, holes are behind side stickers
- Provides 7.5" (19 cm) of total lift (6" hydraulic & 1.5" built-in lift)
- Wiring is plug and play with waterproof Deutch® connectors
- US & International Patents Pending
- Automotive grease fittings
- Adjustable tension rods
- Limited Lifetime Structure Warranty against manufacturing defects
- 5 Year Action Pump Warranty

INCLUDES JACK PLATE, WIRING HARNESS, RELAYS, ROCKER STYLE SWITCH.

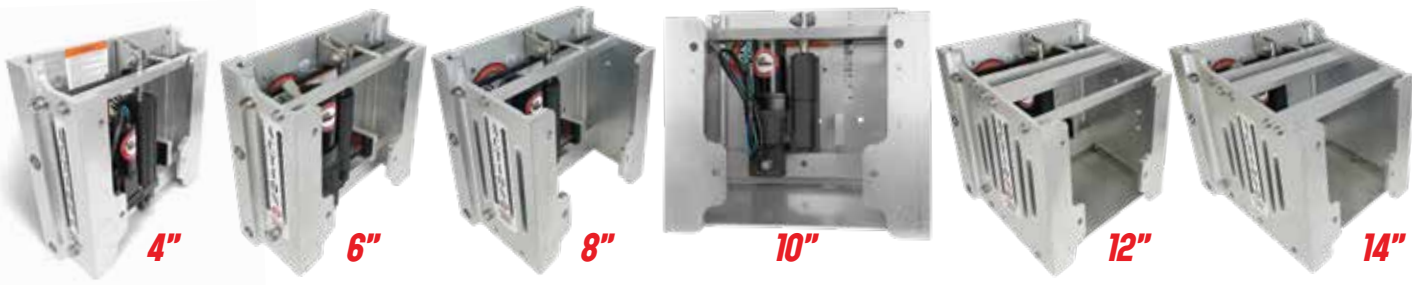
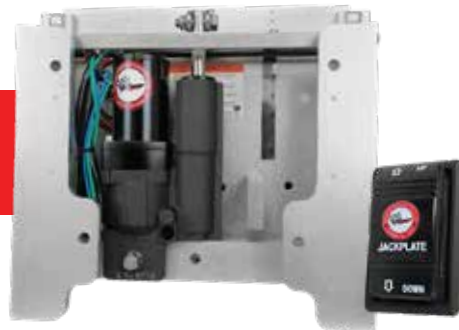

ITEM #	MODEL	PLATE LBS/KILOS	MAX HP/WEIGHT (LBS)	SETBACK (INCHES/CM)
100-104101	4"	46/21	300/625	4/10
100-106010	6"	49/22	300/625	6/15
100-108001	8"	53/24	300/625	8/20
100-111000	10"	58/26	300/625	10/25
100-112112	12"	64/29	300/625	12/30
100-114001	14"	79/36	300/625	14/35

ACTION SERIES JAC™ PLATES

BobsMachine.com
813.247.7040

STANDARD JAC™ PLATES

Our standard series Hydraulic jack plates have been on the market since 1978 and are a proven unit. They have been redesigned, but the concept has remained. The lightest weight hydraulic jack plate on the market! The standard series belief is to keep the least amount of weight on the transom, and by keeping the pump inside the boat, keeps this weight down. All standard series jack plates have a lifetime warranty on the structure to the original end user, and a 5 year warranty on the hydraulic pump motor.

Jack plates are used to improve an outboard boats speed, holeshot, fuel efficiency, and the boater navigate in shallow waters. To help find the correct setback for your boat, give us a call! 1-813-247-7040

Offered in 4", 6", 8", 10", 12" and 14" setbacks, Bob's Jack plates offer 1 piece design, unlike competitors that require setback spacers to achieve the proper setback.



MADE IN THE
USA 



STANDARD JAC™ PLATES

BobsMachine.com
813.247.7040

9

MADE IN THE USA - LIFETIME WARRANTY - 5 YEAR PUMP WARRANTY

STANDARD SERIES FEATURES & BENEFITS

- Jack plates come with: jack plate, pump, wiring harness, 7' hoses, control switch, and oil
- Remote mount pump that connect to jack plate with hoses
- Hydraulic jack plate dimensions: Transom side mounting dimensions: width: 16 3/4" (42.5 cm) height 13 3/4" (34.9 cm)
- Motor side mounting width: 18 1/4" (46.35 cm)
- Mounting height 13 3/4" (34.9cm). Motor side OAW is 18 1/4"
- Provides 7.5" (19 cm) of total lift (6" hydraulic & 1.5" built-in lift)
- Predrilled for side mount shallow water anchors, holes are behind side stickers.
- Limited lifetime warranty
- Predrilled for side mount shallow water anchors, holes are behind side stickers.
- Less weight on transom, pump stays dry in internal location
- Automotive grease fittings
- Adjustable tension rods



HYDRAULIC PUMP ASSEMBLY INCLUDED

Complete with solenoids, wiring harness, wall mounting plate, and two 90 degree fittings. Pump has 5 year warranty. Optional Floor Mount Bracket and optional Pole-Mounting Bracket available. #120-100000

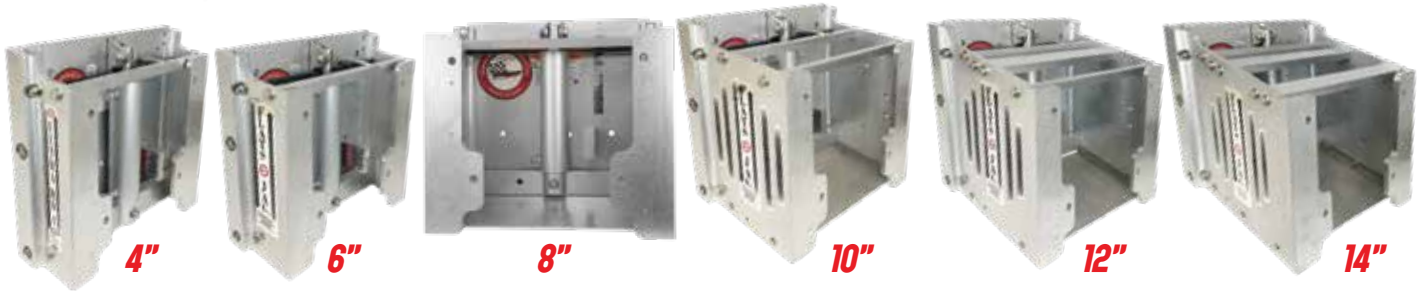

ITEM #	MODEL	PLATE LBS/KILOS	MAX HP/WEIGHT (LBS)	SETBACK (INCHES/CM)
100-104100	4" Standard	38/17	300/625	4/10
100-106000	6" Standard	40/18	300/625	6/15
100-108000	8" Standard	45/20	300/625	8/20
100-110000	10" Standard	49/22	300/625	10/25
100-112000	12" Standard	57/25	300/625	12/30
100-114000	14" Standard	72/32	300/625	14/35

STANDARD JAC™ PLATES

BobsMachine.com
813.247.7040



EXTREME GEN 3 ACTION JAC™ PLATES



**MADE IN THE
USA** 

Bob's Machine Shop has re-engineered their world famous jack plate for new 550+hp engines including V8's.

The New Gen 3 Extreme Action is wider allowing for Verado installation. The Extreme Gen 3 Action has the all in one style pump, built into the jack plate so no hoses or pump to mount inside the boat. This makes rigging the boat extremely easy!

Through innovative engineering, BMS's new Extreme Series (TM) jack plates are their strongest yet.

The Extreme Gen 3 Action series jack plates are available in 4", 6", 8", 10" & 12" setbacks to suit every application.

Jack plates are no longer just for fishing boats, offshore boaters will enjoy the extra speed, and increased fuel economy from BMS's new line. Jack plates are used to improve an outboard boats speed, holeshot, fuel efficiency, and the boater navigate in shallow waters.

To help find the correct setback for your boat, give us a call! 1-813-247-7040



EXTREME GEN 3 ACTION JAC™ PLATES

Bob'sMachine.com

813.247.7040



MADE IN THE USA - LIFETIME WARRANTY - 5 YEAR PUMP WARRANTY

EXTREME GEN 3 ACTION FEATURES & BENEFITS

- Includes jack plate, wiring harness, relays, rocker style switch
- Limited Lifetime Structure Warranty against manufacturing defects
- 5 Year Action Pump Warranty
- Provides 7.5" (19 cm) of total lift (6" hydraulic & 1.5" built-in lift)



4"



6"



8"



10"



12"

ITEM #	MODEL	PLATE LBS/KILOS	MAX HP/WEIGHT (LBS)	SETBACK (INCHES/CM)
100-604005	4"	57.5/20	550/1200	4/10
100-606005	6"	63/29	550/1200	6/15
100-608005	8"	68/31	550/1200	8/20
100-610005	10"	74/34	550/1200	10/25
100-612005	12"	82/37	550/1200	12/30.5

EXTREME GEN 3 ACTION JAC™ PLATES

BobsMachine.com
813.247.7040

EXTREME GEN 3 STANDARD JAC™ PLATES

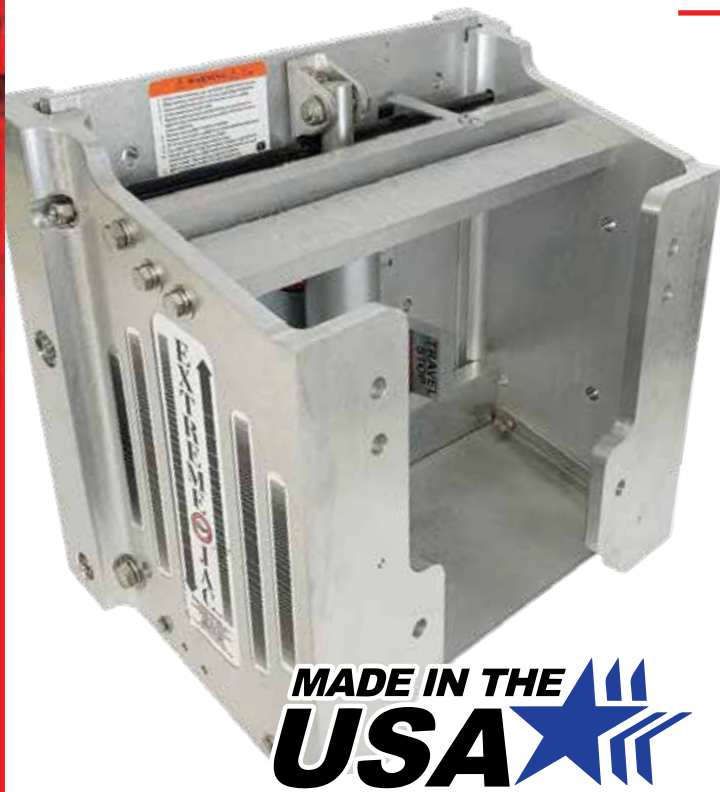

**MADE IN THE
USA** 



HYDRAULIC PUMP ASSEMBLY INCLUDED

Complete with solenoids, wiring harness, wall mounting plate, and two 90 degree fittings. Pump has 5 year warranty. Optional Floor Mount Bracket and optional Pole-Mounting Bracket available.

#120-100000

Bob's Machine Shop has re engineered their world famous jack plate for new 550+hp 1000lbs engines including V8's.

The New Gen 3 Extreme is wider allowing for Verado installation without the use of spacers.

Through innovative engineering, BMS's new Extreme Series Jac™ Plates are their strongest yet.

The Extreme series jack plates are available in 4", 6", 8", 10", & 12" setbacks to suit every application.

Jack plates are no longer just for fishing boats, offshore boaters will enjoy the extra speed, and increased fuel economy from BMS's new line. Jack plates are used to improve an outboard boats speed, holeshot, fuel efficiency, and the boater navigate in shallow waters. *To help find the correct setback for your boat, give us a call! 813-247-7040*

Extreme Gen3 standard series – Remote mount pump, 7' hose set, switch, oil, and all wiring required. For all in one jack plate, see Extreme Gen3 Action series.



EXTREME GEN 3 STANDARD JAC™ PLATES

Bob'sMachine.com

813.247.7040

10

MADE IN THE USA - LIFETIME WARRANTY - 5 YEAR PUMP WARRANTY

EXTREME GEN 3 STANDARD FEATURES & BENEFITS

- Gen 3 is wider for the Mercury® Verado® outboard bracket
- Rated to 550HP
- Predrilled for side mount shallow water anchors, holes are behind side stickers
- Provides 7.5" (19 cm) of total lift (6" hydraulic & 1.5" built-in lift)

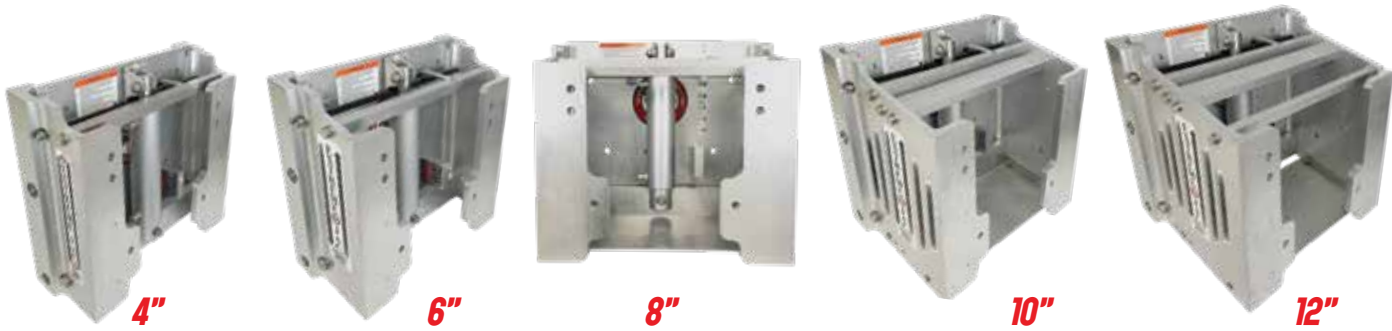

ITEM #	MODEL	PLATE LBS/KILOS	MAX HP	SETBACK (INCHES/CM)
100-604002	4"	51/23	550	4 5/8/11.7
100-606002	6"	54/24.5	550	6/15
100-608002	8"	61/28	550	8/20
100-610002	10"	65/29.5	550	10/25
100-612002	12"	74/33	550	12/30.5

NEW ULTRA EXTREME JAC™ PLATE

- 94lbs
- 4" setback
- Rated to 700hp
- Hole pattern for Mercury 600hp v12 and BIA Twin cylinder technology
- Bob's Double Jack Pump & flow divider



**WATCH THE VIDEO!
SNAP THE QR CODE FOR
YOUTUBE VIDEO.**

EXTREME GEN 3 STANDARD JAC™ PLATES

**BobsMachine.com
813.247.7040**



RACE SERIES JAC™ PLATES

Bob's New RACE SERIES jack plates are a racers dream!
Available in 4", 6", 8", 10" or 12" setback

The first race specific jack plate from Bob's, and the first ever race specific vertical lift jack plate with Hydraulic options!

Transom side plate with patent pending interlocking system to the side rails. Machined excess material off of plate to save weight!

Rated for 550HP race motors.



MADE IN THE
USA 



RACE SERIES JAC™ PLATES

BobsMachine.com

813.247.7040

12

FIRST EVER RACE BOAT SPECIFIC HYDRAULIC JACK PLATE TO THE MARKET

RACE SERIES FEATURES & BENEFITS

- Reduced flex = Better hole shot, consistent prop angle
- Reduced lateral side shifting = Better handling characteristics
- Easy setback changes = Does not require unbolting from transom to change setback
- Designed to withstand abusive racing conditions and impacts associated with offshore racing
- Innovative machining techniques for reduced weight, & lattice style strength
- Provides 7.5" (19 cm) of total lift (6" hydraulic & 1.5" built-in lift)
- Thicker slide plates and components for reduced material fatigue & long life
- Pre-drilled for shallow water anchors *Requires Bob's Race Jac™ Side Spacer*
- Offered in all Bob's series: Action, Standard & Versa, giving total choice to the boater
- Standard Silver color, optional anodized blue, red, and black colors available
- Limited lifetime structure warranty
- Patent pending
- More offset panels coming soon
- Predrilled with Basscat Transom hole pattern

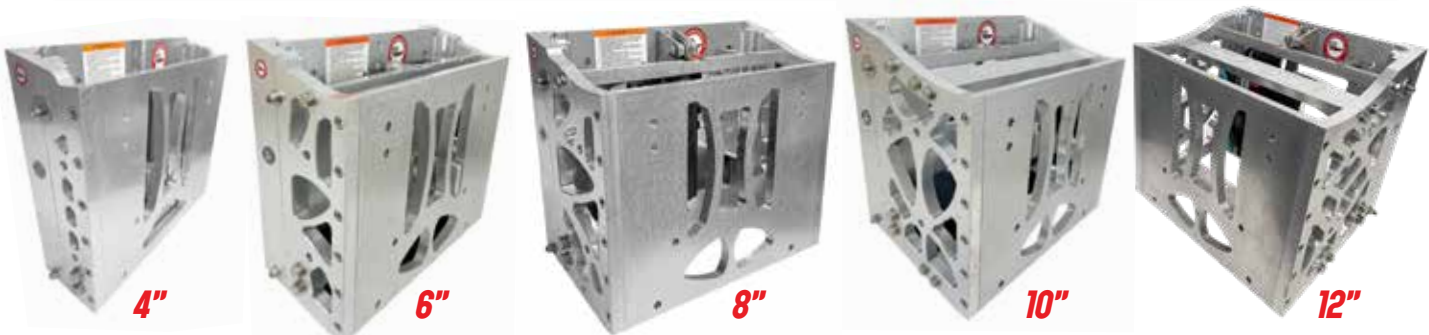

ITEM #	DESCRIPTION	PLATE LBS/KILOS
100-114999	4" Standard Race Jac	63/28.5
100-116999	4" Versa Race Jac	64/29
100-115000	6" Standard Race Jac	68.5/31
100-116000	6" Action Race Jac	74.5/34
100-117000	6" Versa Race Jac	69/31
100-115001	8" Standard Race Jac	71/32
100-116001	8" Action Race Jac	78/35.5
100-117001	8" Versa Race Jac	72/32.5

ITEM #	DESCRIPTION	PLATE LBS/KILOS
100-115002	10" Standard Race Jac	79.5/36
100-116002	10" Action Race Jac	85.5/39
100-117002	10" Versa Race Jac	80.5/36.5
100-115003	12" Race Standard Series	83/37.5
100-116003	12" Race Action series	90/41
100-117003	12" Race Versa series	85/38.5

AVAILABLE IN:

- STANDARD
- VERSA
- ACTION



RACE SERIES JAC™ PLATES

BobsMachine.com
813.247.7040

CUSTOM FINISHES ACTION JAC™ PLATES



Custom colors now available! Power pole & talon color matches available. All powdercoating is done in-house!

CALL TODAY TO DISCUSS YOUR CUSTOM NEEDS!

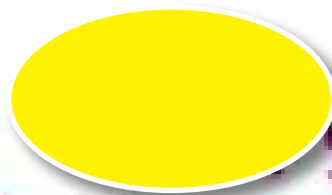
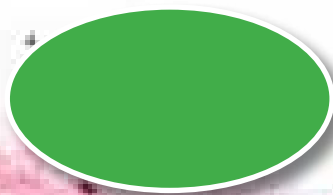

***IF YOU CAN THINK IT
THE POSSIBILITIES ARE PRACTICAL***

CUSTOM FINISHINGS ACTION JAC™ PLATES

***BobsMachine.com
813.247.7040***

COLOR SERIES JACK PLATES - POWDERCOAT

Our new color series jack plates - Available in durable Powdercoated solid colors. Choose the Jac™ Plate that's right for you, then, add a custom powdercoated color really make your boat special! Choose from a wide variety of Powdercoat colors. When purchasing a custom jack plate, add both the jack plate of choice, as well as the custom color item to your shopping cart.

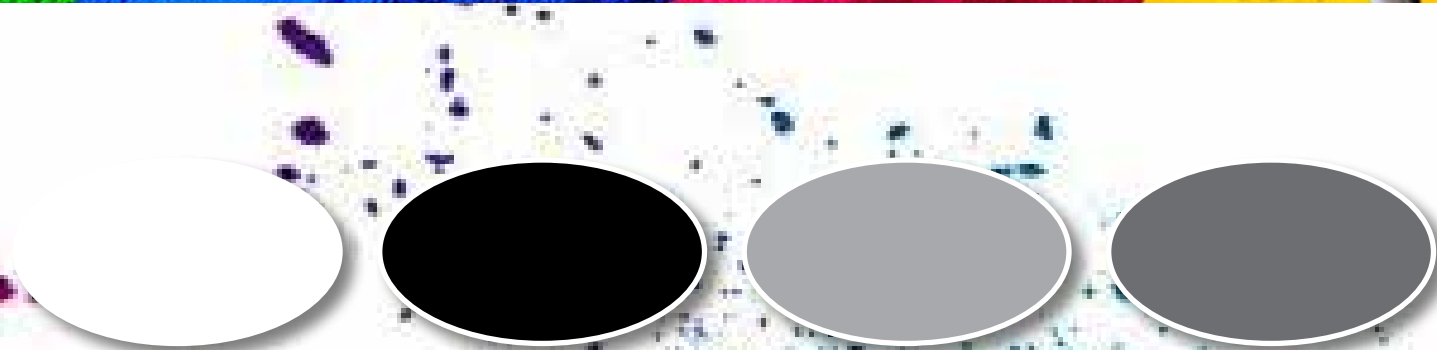

AT, BOB'S CAN DO IT!
ALLY UNLIMITED! CALL TODAY!!

CUSTOM FINISHES ACTION JAC™ PLATES

BobsMachine.com

813.247.7040

15

VERSA JAC™ PLATES

VERSA JAC™

- Manually operated jack plate
- Easily upgrades to full hydraulic operation if desired
- Simple to remove manual screw assembly and swap it out for a hydraulic cylinder
- Patented Versa Jac™ has the same look as Bob's popular line of hydraulic jacks
- Rated for engines up to 300 hp, 625 lbs max.
- Manually operated jack plate easily adjusts for optimum results while on the water
- Includes limited lifetime warranty
- Versa Jac™ plate dimensions: Transom side mounting dimensions: Width: 16 3/4" (42.5 cm), Height 13 3/4" (34.9 cm). Motor side OAW is 18 1/4"
- Motor side mounting width: 18 1/4" (46.35 cm)
- Predrilled for side mount shallow water anchors, holes are behind side stickers.
- Provides 7.5" (19 cm) of total lift (6" hydraulic & 1.5" built-in lift)
- Automotive grease fittings
- Adjustable tension rods



Snap the QR code, for Extreme Versa plate adjustment video

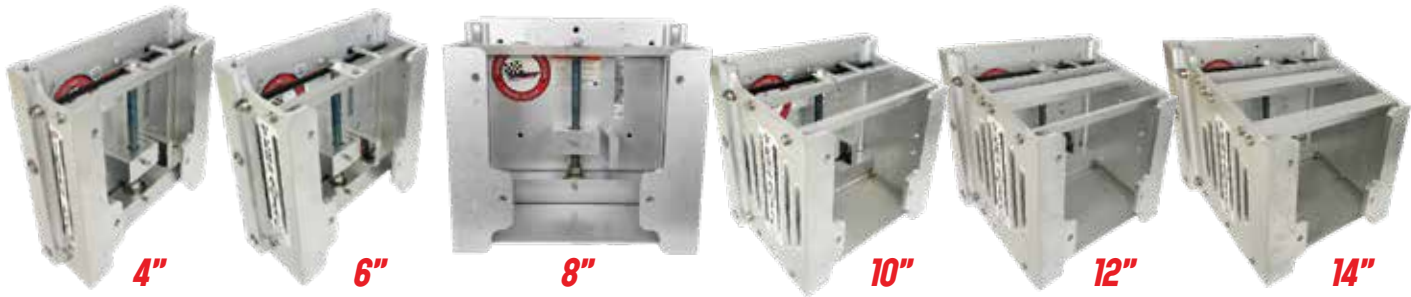

ITEM #	MODEL	PLATE LBS/KILOS	MAX HP/WEIGHT (LBS)	SETBACK (INCHES/CM)
100-504100	4" Versa	40/18	300	4/10
100-506000	6" Versa	41/18	300	6/15
100-508000	8" Versa	45/20	300	8/20
100-510000	10" Versa	49/22	300	10/25
100-512000	12" Versa	56/25	300	12/30
100-514000	14" Versa	71/32	300	14/35

VERSA JAC™ PLATES

BobsMachine.com
813.247.7040

EXTREME VERSA JAC™ PLATES



Snap the QR code, search YouTube for "7 Marine 627hp, Barker Boatworks"

EXTREME GEN 3 VERSA

The standard Versa Jac™ can be upgraded with an upgrade kit to either Standard series jack plates, or to Action series jack plates. Upgrades on the Extreme Versa convert them to the normal Extremes which is only 'standard' style pump (inside the boat with hoses).

- Predrilled for side mount shallow water anchors, holes are behind side stickers.

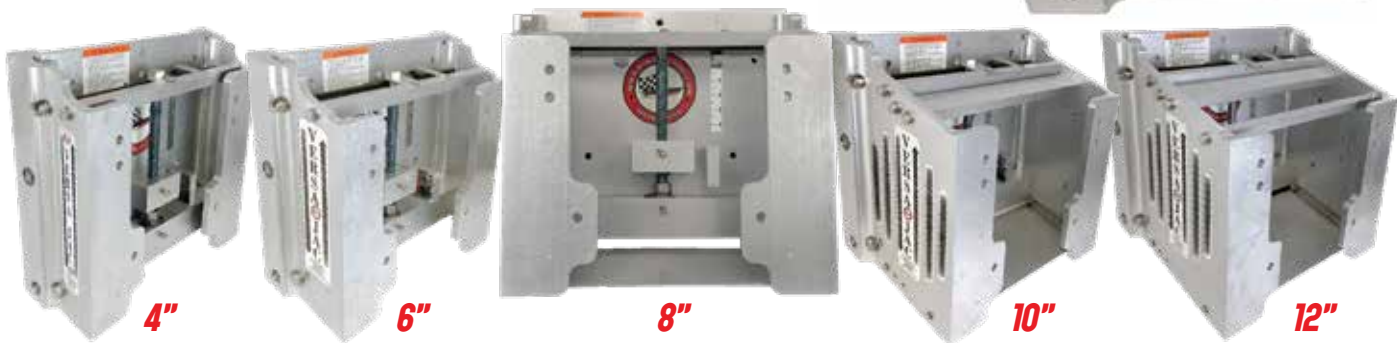

ITEM #	MODEL	PLATE LBS/KILOS	MAX HP/WEIGHT (LBS)	SETBACK (INCHES/CM)
100-604003	4" Extreme Versa	54/24.5	550	4 5/8/ 11.7
100-606003	6" Extreme Versa	57/26	550	6/15
100-608003	8" Extreme Versa	64/29	550	8/20
100-610003	10" Extreme Versa	73/33	550	10/25
100-612003	12" Extreme Versa	76/35	550	12/30.5

VERSASAJAC™ UPGRADE KIT

For Classic Versa 4-6": #100-500000 (shown)

For Classic Versa 8-14": #100-500100

For Action Versa 6-12": #100-500101

Pre 2020 Action 6"+ retrofit to new style action pump kit: #100-500009

Pre 2020 Extreme Action 6"+ retrofit to new style action pump kit: #100-500010

Pre 2020 Mini Action 6"+ retrofit to new style action pump kit: #100-500011

For 8" and up jack plates only: #100-510000

Upgrade kit for mini Versa Jac™: #100-5xxxxx

Includes everything you need to upgrade your Versa Jac™ to hydraulic operation.

+CUSTOM MADE HOSES TO ANY LENGTH!



EXTREME VERSASAJAC™ PLATES

BobsMachine.com
813.247.7040



KICK-BACK JAC™ PLATES



KICK BACK JAC™ PLATE AKA "STUMP JUMPER"

- 28 lbs total weight
 - Width – 17.5", Height – 6", Offset – 5.5"
 - 45 degree tilt up (kick up)
 - Delrin rollers and bearings for smooth operation; No need for chains or spring like competition
 - Motor tether attachment point for safety
 - Locking pins to prevent plate from kicking out in reverse or trailering
 - Greaseable pivot points – automotive Zerk fittings
 - Patent pending
 - Rated up to 115 HP motors – BIA bolt pattern
 - Optional clamp on style kit available
- #100-105000



WARNING: This unit is rated for outboard motors up to a maximum of 115 H.P. Do not encounter obstructions at speeds over 5 M.P.H and only in the forward direction. It is not designed or intended to encounter obstructions while the boat is being operated in the reverse direction.



Snap the QR code, for Stump Jumper video.

HYDRAULIC KICK BACK JAC™

- 6" hydraulic lift, and 1.5" structure lift for total of 7.5" max lift
 - 48 lbs
 - Rated to 115 HP
 - Locking pins for reverse
 - Grease able pivot points and slide plate area
 - No spring or chains
 - Tensioning rod
 - 30 degree of tilt
 - Patent pending
 - Powder coating available
- # 100-105100

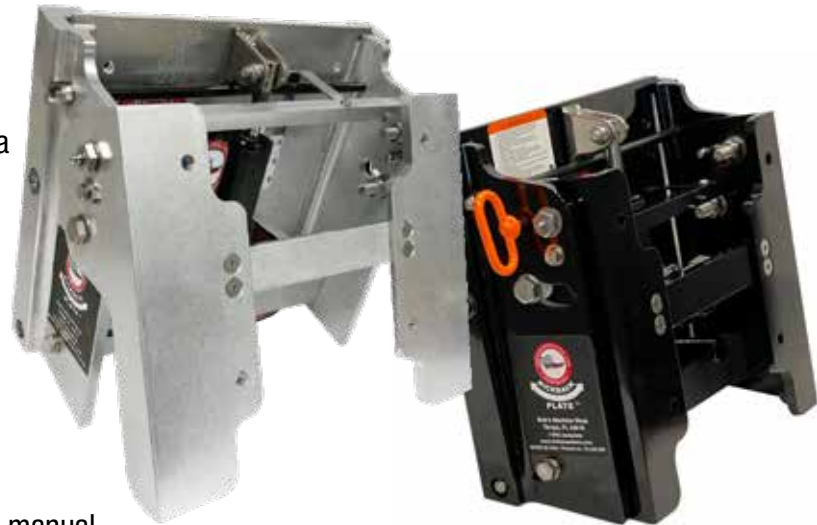

VERSA KICK BACK JAC™

Same as the hydraulic version, with our Versa manual operation for jack plate height. #100-105200

PIN HOLDER

- Pins not included - Uses pins that come with Kick Back plate
 - Works with either style Kick Back plate
 - Bolts onto Kick Back plate to hold pins so you don't lose them
- #100-105002



MINI JAC™ PLATES

MINI HYDRUALIC JAC™ PLATES

STANDARD MINI PLATE

Designed for motors up to 50 HP that have the standard BIA bolt pattern. 7.5”(19cm) of hydraulic lift, pump mounts inside boat, limited lifetime warranty. 28 pounds (12 kilos). 14 7/8” (37cm) OAL. 17 3/4” (45cm) OAW. 6” (15cm) set back. Standard mini jack for clamp on style motors available, #100-812000

NARROW MINI PLATE

Designed for motors up to 50 HP that have transom mounting clamps. 7.5”(19cm) of hydraulic lift, pump mounts inside boat, limited lifetime warranty. 25 pounds (11 kilos). 14 3/4” (37cm) OAL. 13 1/4” (33cm) OAW. 6” (15cm) set back. #100-810000

MICRO PLATE 4” STROKE

For small transoms such as Gheenoe or other squareback canoes. #100-820000

MINI ACTION SERIES JAC™ PLATES

40 pounds (18 kilos)

Full size for BIA bolt pattern Mini Action 6” #100-801000
Narrow Mini Action for clamp on motors 6” #100-811000

ACTION AND STANDARD JAC™ PLATES FEATURE A 5 YEAR WARRANTY ON THE PUMP, LIMITED LIFETIME WARRANTY ON THE THE STRUCTURE.

MINI VERSA JAC™ PLATES

- Manually operated jack plate for smaller boats or micro skiffs
- Easily upgrades to full hydraulic operation if desired
- Rated up to 50
- Easily upgrades to full hydraulic operation
- Adjustable on the water
- Standard mini versa for clamp-on style motors available
- Limited lifetime warranty

VERSA MINI UPGRADE KITS:

- #100-500001 - For Standard mini full size
- #100-500002 - For Standard mini narrow
- #100-500003 - For Standard mini micro

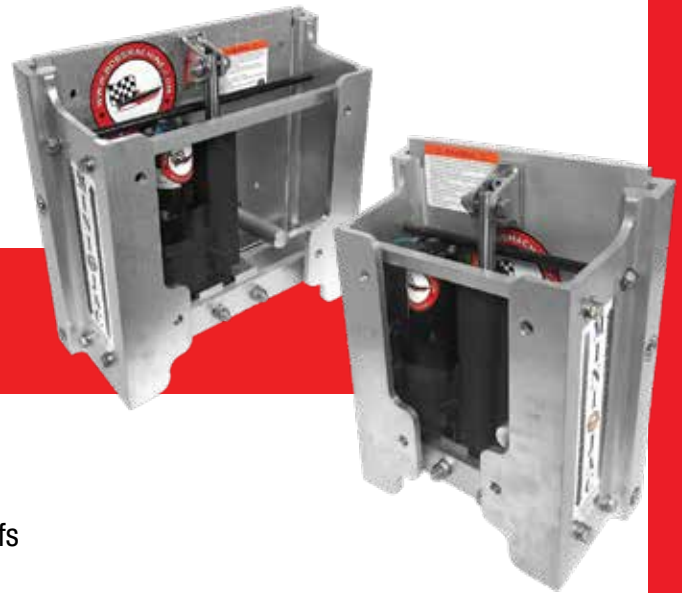

STANDARD
#100-870000
28lbs/12kilos

NARROW
#100-860000
28lbs/12kilos

MICRO
#100-850000
18lbs/8kilos

MINI JAC™ PLATES

BobsMachine.com
813.247.7040

NEW TILT & JACK COMBO!

COMBO TILT AND JACK IN ONE UNIT

- 1 hydraulic pump to control both cylinders via integrated solenoid valve.
- 6 inches hydraulic travel + 1.5 inch lift built into structure
- 40lbs/18kgs
- Rated 50HP
- 75 Degree tilt
- Delrin slide bushings
- Full BIA Bolt pattern
- Made in USA
- Complete kit, hoses, oil, switch, etc.

Can be customized packages for OEM customers.

#100-106016



TILT & JACK VERSA

Same features as the Tilt & Jack Combo, except:

- Manual Jack function
- Hydraulic tilt
- 35lbs/16kgs

#100-106018

ACTION TILT & TRIM

An 'All In One unit', just connect power and switch wires.

Relay assembly, wiring harness, stackable spacers, and switch all included.

- Overall mounting dimensions: 11.5" wide, 10" long
- Clamp on motors only
- 35HP max
- Weighs 20 lbs/9.07kg

#100-701100



NEW ACTION TILT & TRIM

FOR BIA HOLE PATTERN MOTORS UP TO 115HP

- Integrated Action series pump
- 39.5 lbs / 18kg weight
- 6" setback

#100-700501

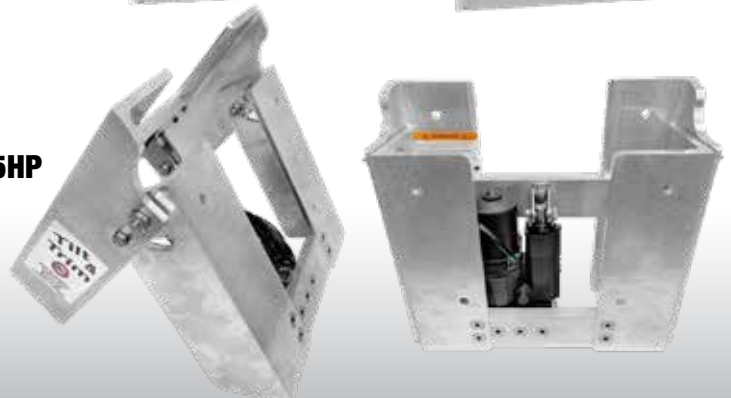

DOUBLE AND TRIPLE JACS

DOUBLE & TRIPLE JAC™

The first vertical lift jack plate for twin or triple outboard engines. Rated for dual or triple 550hp engines, providing user with higher performance, and increased fuel economy, as well as the ability to go in shallow waters.

- One piece design, no longer having to worry about keeping engines in 'sync'
- Raises twin outboards 7.5" above the factory mounting point in 10 seconds
- One high speed pump control dual cylinders
- Includes one control switch and LED gauge
- Powder Coated color to suit customer needs
- Limited lifetime warranty
- Multiple US & Intl patents pending
- Automotive grease fittings
- Adjustable tension rods

CALL FOR TECHNICAL ADVICE ON DUAL, TRIPLE AND QUAD MOTOR INSTALLATIONS!



THE SPLITTER JAC™

SINGLE ENGINE MOUNTING TO DUAL ENGINE JACK PLATE

- Utility patent pending
- Rated to twin 225hp
- Twin cylinder technology w/custom high speed pump & flow divider
- Custom powder coating
- Made in USA
- Add the twin engine dockside manners to single engine boat
- Feel comfortable offshore with twin engines so you know you'll always get home!

#100-106014

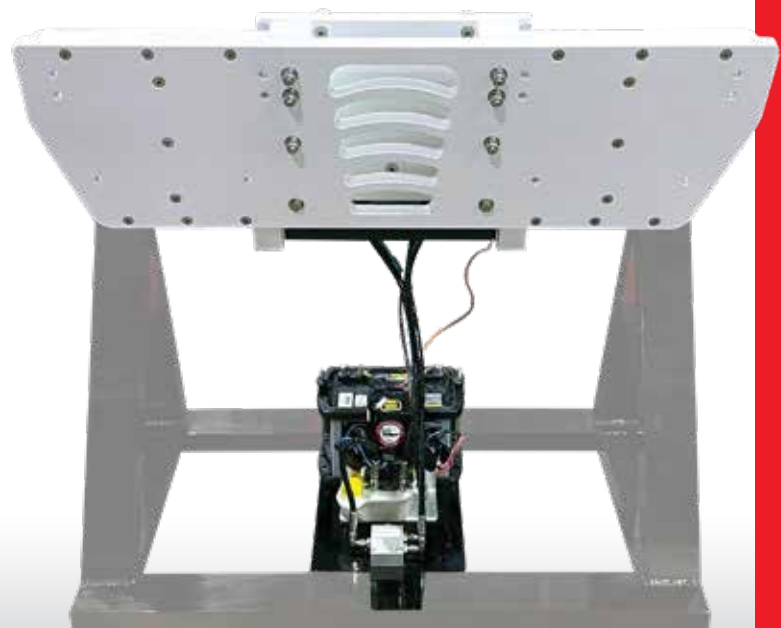

DOUBLE AND TRIPLE JACS

BobsMachine.com
813.247.7040

KICKER JAC™

- Maximum engine rating to 40 hp 4 stroke motors
- Provides low speed power for cruisers
- Auxillary power for sailboats
- Trolling power for fishermen
- Patented design has 16" (40.6cm) of lift
- Custom hose lengths are available
- Through the hull fittings available
- Bob's hydraulic jack plate motors are mounted inside the boat for long life and easy maintenance
- Optional wireless control kit available
- Kicker Jacs come with: kicker jack, pump, wiring harness, 10' hoses, control switch, & oil
- Includes limited lifetime warranty against structural defects
- Weighs 48 pounds (21.7kg)

#100-300000



MINI MANUAL JAC™ PLATES FOR MINI BAOTS

MANUAL JAC™ PLATE

- *Mini Manual – Only 12 lbs. (5.4kg)*
- *Variable Horizontal Offset – Plate can be set at three different horizontal dimensions. 4-1/4" (10.7cm) setback, 5" (12.7cm) setback, and 6-1/8" (15.5cm) setback, to achieve optimum performance and handling (40 HP 2 stroke max).*
- *Clamp-on only motors without power tilt/trim*
- *2.5" built in, plus 1.5" adjustable for total of 4" lift*

100-200500: 11.5" Width

100-200600: 15.25" Width

100-200100: 18" Width



STACKABLE SPACERS

Set of 6". #100-704000



STATIC MOTOR PLATE

RSM International, inc., inc has developed a rigid mounting plate that will prevent damage or scratching to the finish of the back of your boat when mounting a clamp-on style kicker, auxiliary outboard motor, or transom mount electric trolling motor. This plate provides a stable, secure, and flat mounting area for your clamp-on style motor up to 25 hp or 150 lbs gasoline powered outboard motor and all electric motors. Designed with a 4-bolt mounting pattern that will keep the mounting holes above the water line and is manufactured out of 6061 t6 aluminum for use in any marine environment. Comes with Bob's limited lifetime warranty.

#100-900000 - Standard Static Motor Plate



MINI MANUAL JAC™ PLATES

BobsMachine.com
813.247.7040

SETBACK BRACKETS

SETBACK BRACKETS



SET BACK BRACKETS

- All rated to 550 hp without cross bars
- Optional rigid crossmembers available
- Have 1.5" of lift built into structure
- 2 mounting hole positions, to offer up to 2.5" of lift
- Mercury® outboards require optional cross bars or might void engine warranty (*10" setback brackets come standard with cross bars)

Item #	Size
100-404000	4"
100-406000	6"
100-408000	8"
100-410000	10"



NO LIFT SETBACK BRACKETS

Great for boaters that need setback without lift, or wish to use these on their jack plate to get extra setback. Bolts between transom and jack plate, not for use on motor side.

Add Bob's 2" Bolt kit to attach to jack plate.

Item #	Size
100-404002	4"
100-406003	6"
100-408003	8"
100-410001	10"



OPTIONAL CROSS BARS FOR SETBACK BRACKETS

- 120-235004 – Optional cross bars for 4" Setback
- 120-235006 – Optional cross bars for 6" Setback
- 120-235008 – Optional cross bars for 8" Setback
- # 100-400001

5" VERTICAL EXTENTION BRACKETS

- Lift engine 5" with only 0.625" extra setback
- Perfect for boater using XL shaft motor on a boat that doesn't require the extra 5"
- Works on all motors except 425 Yamaha
- Up to 450HP
- # 100-400001



TRANSDUCER MOUNTS FOR JACK PLATES

Stainless steel, powder coated high gloss black to mount most popular transducers to jack plate. Don't worry about drilling into boat, now you can just bolt onto your jack plate and mount your transducer!

#110-500000 Fits all Bobs 8, 10, 12, & 14" standard/action/extreme/versa jack plates

#110-500001 Fits Bobs 4 & 6" jack plates. Older years will have to drill sides to fit, template included.



BACKING PLATES

(UPPER & LOWER SETS)

Can be customized for OEM manufacturers

- Manufactured out of aircraft grade aluminum

#110-200000

Upper backing plate: 2.5" X 15.5" X 3/8"

Lower backing plate: 2.5" X 13" X 3/8"



DOUBLE BOLT TOP BACKING PLATE

F350 bolt pattern #110-200501

With lower plate #110-200500



REPLACEMENT ANODES

For any Motor: #300-xxxxxx

Jack Plate Anode: #300-000000

SPLASH PLATES

For 4" and 6" jack plates

#120-210400 - 4"

#120-210600 - 6"

#100-210601 - 6" Gen3 action splash plate

#120-120804 - 8" Gen3 action splash plate

#120-211002 - 10" with performance lip

#120-211201 - 12" with performance lip

LIFT PLATE LED GAUGES

SOLID STATE ONE OF A KIND TECHNOLOGY

- Unique solid-state transducer
- Sensor reads every ¼" rise and lights a corresponding LED
- 1-Year Warranty
- Available with white or black face and with or without polished stainless steel bezel
- Dual gauge kit available

For all Bob's Jack Plates:

- #110-300000 - Black gauge kit
- #110-300001 - Black gauge w/ Stainless steel bezel
- #110-310000 - White gauge kit
- #110-311000 - White gauge w/ Stainless steel bezel



GAUGE EXTENSION CABLES

Extends LED height indicator gauge up to 14'

#110-330003

NMEA CONNECTOR

- Garmin™ & Humminbird™ supported. More brand support coming soon
- Connect your Bob's Machine jack plate to your Multi-Function Display and view your jack plate height
- Simple plug and play technology into your NMEA backbone

#110-400000 - For boat that already has Bob's LED Gauge installed

#110-400001 - For boat that already has Bob's sending unit installed (No gauge)

#110-400003 - Complete without gauge (only view on graph)

#110-400004 - Complete with Black Gauge

#110-400005 - Complete with Black Gauge & Stainless Steel Bezel

#110-400006 - Complete with White Gauge

#110-400007 - Complete with White Gauge & Stainless Steel Bezel



Snap the QR code, for Scott Martin ICAST NMEA Connector for Garmin

JAC™ PLATE ACCESSORIES

BobsMachine.com
813.247.7040

27

JAC™ PLATE ROCKER SWITCH

Includes switch, bezel and heat shrink spade connectors.
#305-900000



JAC™ PLATE ROCKER SWITCH REMOVAL TOOL

#305-900002

TRANSOM TRIM CONTROL

This Transom Trim Control provides a weatherproof tilt control system at the stern area of the boat to facilitate placing motor support position with one person. Switch can also be used for remote adjustment of hydraulic jack plates. The switch housing is molded black plastic with raised white letters and may be mounted on any flat surface. Comes with 18" pigtail wire.
#305-500000



WIRELESS REMOTE CONTROLS

- Adjust the jack's height easily with a key fob from anywhere — on or off the boat
- Ideal during docking or trailering when there is limited access to dash-mounted switch
- Anglers with towers can conveniently operate jack plates with key fob
- Compatible with all BMS jack plates
- Works independently from dashmounted switch

#305-700000 - Standard

#305-711000 - Action



BOB'S STEERING WHEEL SWITCH

Trim or jack plate control at your fingertips with a column-mounted switch that looks great in any console. You can keep your hands on the wheel and concentrate on driving. Bolts to most systems, including mechanical and hydraulic. All hardware included. Single-switch 1000 mounts at 3 or 9 o'clock stalk positions.

#305-330000 - Single (Plastic switches & bodies)

#305-340000 - Dual (Plastic switches & bodies)

Bob's New Pro Series steering wheel switches feature aluminum stalks, aluminum housings, and new upgraded switches with a heavy duty detent, and heavy duty spring, specifically engineered for loud clicks and to handle the weight of the metal stalks.

#305-330001 - Single Pro Series

#305-340001 - Dual Pro Series



SWITCH SPLITTER

Connect 2 location for making jack plate adjustments. Perfect for tower or bow controls.

#305-900004 - Splitter

#305-900005 - Splitter and 16' switch wire

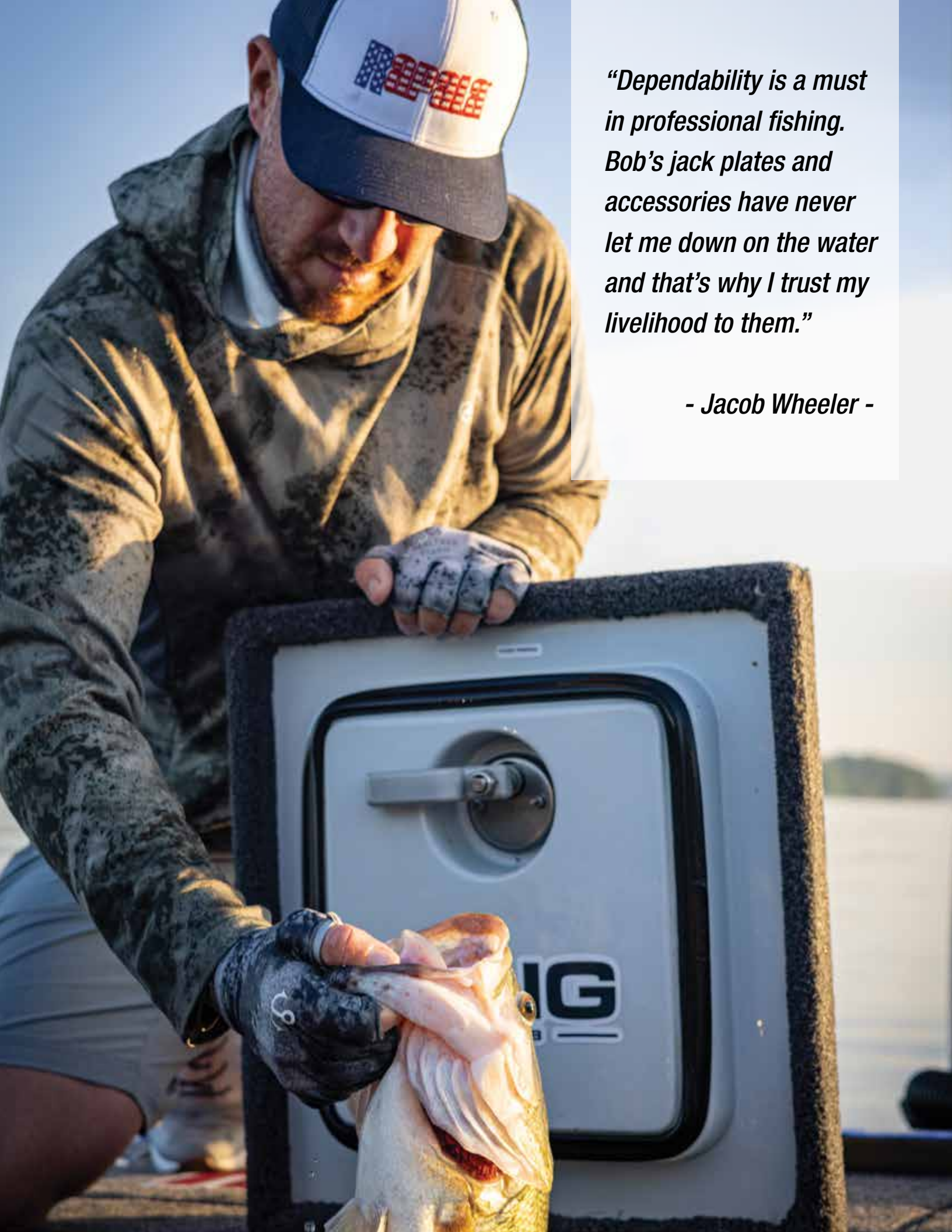

“Dependability is a must in professional fishing. Bob’s jack plates and accessories have never let me down on the water and that’s why I trust my livelihood to them.”

- Jacob Wheeler -

HARDWARE

BOB'S THRU HULL FITTINGS

#120-510000

THRU HULL FITTINGS

with mounting hardware

#120-515000

TRANSOM WASHERS

#110-202100

BULK HEAD FITTINGS

#120-520000

4" BULK HEAD FITTINGS

#120-520001

BOLT KIT

(3.5" and 2.5") Includes flat washers, lock washers, bolts, and lock nuts.

#110-100000

Other bolt lengths available.



TRANSOM HOLE PLUG

O-ring seal plug and machined nut, used to close the hole left from removed Thru-hull fittings

#120-510001

BRUSH KIT

#120-120005



MERCURY® FLYWHEEL PULLER

Fits all V6 Mercury® motors except Verado 225 and up.

#405-120000



STAINLESS STEEL FITTINGS

3-PIECE FITTINGS

Bob's Jack Plate Hose to JIC4.

#120-500000



CRIMP ON FITTING

Bob's Jack Plate Hose to JIC4.

#120-500001



90-DEGREE MALE TO FEMALE

JIC4 to JIC4 for people wanting to route hoses straight up out of Jack Plates, great on tight applications!

#600-551804



STAT-O-SEAL

Washer with O-ring impregnated into it. For use between Bob's hydraulic cylinder and cylinder fitting.

#120-231101



LIFTING EYE

The Lifting Eye bolts onto flywheel with hardened bolts furnished. Lifts engine in a vertical position and allows one person to install motor.

#317-000000 - Johnson-Evinrude V-4 and V-6 1977 and newer

#405-000000 - Mercury® Lifting Eye – All (except Verado 200 hp and up)

#405-200000 - Mercury® Verado/ Yamaha SHO Lifting Eye and flywheel puller



BMS EMERGENCY BOARDING LADDER

- Oil impregnated bearing to reduce chatter and to reduce binding from metal on metal contact in salt water
- Stainless steel deployment pin
- Lightweight
- Rubberized steps for comfort and safety
- Lifetime warranty
- Will attach directly to the side of BMS 8" –14" jack plate
- Custom powder coatings and
- Ceramic Cerakoting available on ladders

#450-000000 - Port side ladder

#450-100000 - Starboard side ladder

Bracket require for 4 or 6" jack plates (can be used with 8+" also for a no drill installation)

#451-100000 - Starboard

#451-000000 - Port

Bracket for use with no jack plate

#451-000002 - Starboard

#451-000001 - Port

Also requires #451-100000

LADDER BRACKET

Can be used on either side, mounts to shallow water anchor side holes. Complete kit includes spacer & bolts.

#451-300000

NEW! BSA PROP DOCK

Now you can mount your prop securely in your boat with our patent pending BSA Prop Dock! No more having your expensive prop loose in your compartments, or taking up tons of room with large cases. Mounts securely to the floor with included hardware. The top block that holds prop in place doubles as a prop removal block that slides over your cavitation plate to hold in place if you have to do a prop change on the water/beach.

Made in the USA!

#398-200000



ACTION REPLACEMENT COMPONENTS

WIRING

ACTION SERIES RELAY

- #120-150011 - Wiring harness
- #120-150010 - With switch wire
- #120-150012 - Switch wire only



REPLACEMENT BEARINGS

- #120-200000
- #120-200006 - For Extremes and 14" jack plate



STICKER KIT FOR JAC™ PLATES

Available for all models. See website for more info.

#820-6xxxxx

40-AMP BREAKER

for Action Jac™ wiring harness

- Has a reset button, silicon cover for added protection and stainless steel nuts
- #649-460040



RED BOOT for Breaker

#649-460041



Snap the QR code, for Action pump change video

REPLACEMENT ACTION PUMPS

- #120-120016B - 4" Action series replacement pump
- #120-120016 - 6" and larger offset Action series replacement pump
- #120-120019B - Tilt and Trim Action series replacement pump



STANDARD REPLACEMENT COMPONENTS



JAC™ PLATE SOLENOIDS

#120-110000

RETROFIT SOLENOID KIT

#120-150004 - Without wiring harness

#120-150003 - With wiring harness

WIRING HARNESS

#120-150000

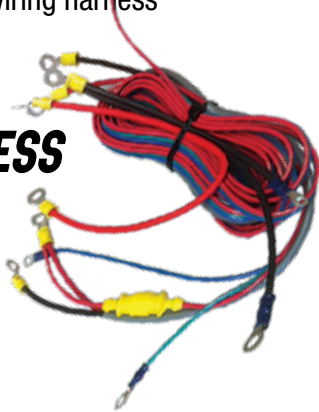

PUMP MOUNTING PLATE

#120-123055



FLOOR MOUNT BRACKET

For hydraulic pump.

#120-121000



POLE MOUNT BRACKET

For hydraulic pump.

#120-123000



HYDRAULIC PUMP ASSEMBLY

Complete with solenoids, wiring harness, wall mounting plate, and two 90 degree fittings. Pump has 5 year warranty. Optional Floor Mount Bracket and Optional Pole-Mounting Bracket available.

#120-100000

JACK PLATE CYLINDERS

#120-230501 - 1" shaft for all 8"

Standard series jack plates and all Extreme series jack plates.

#120-230000 - 3/4" shaft for all 4-6" standard jacks.

Call for all other applications.



CYLINDER FITTING

Stainless steel fitting for jack plate cylinder to hydraulic hose

#630-104000



STANDARD REPLACEMENT COMPONENTS

BobsMachine.com
813.247.7040

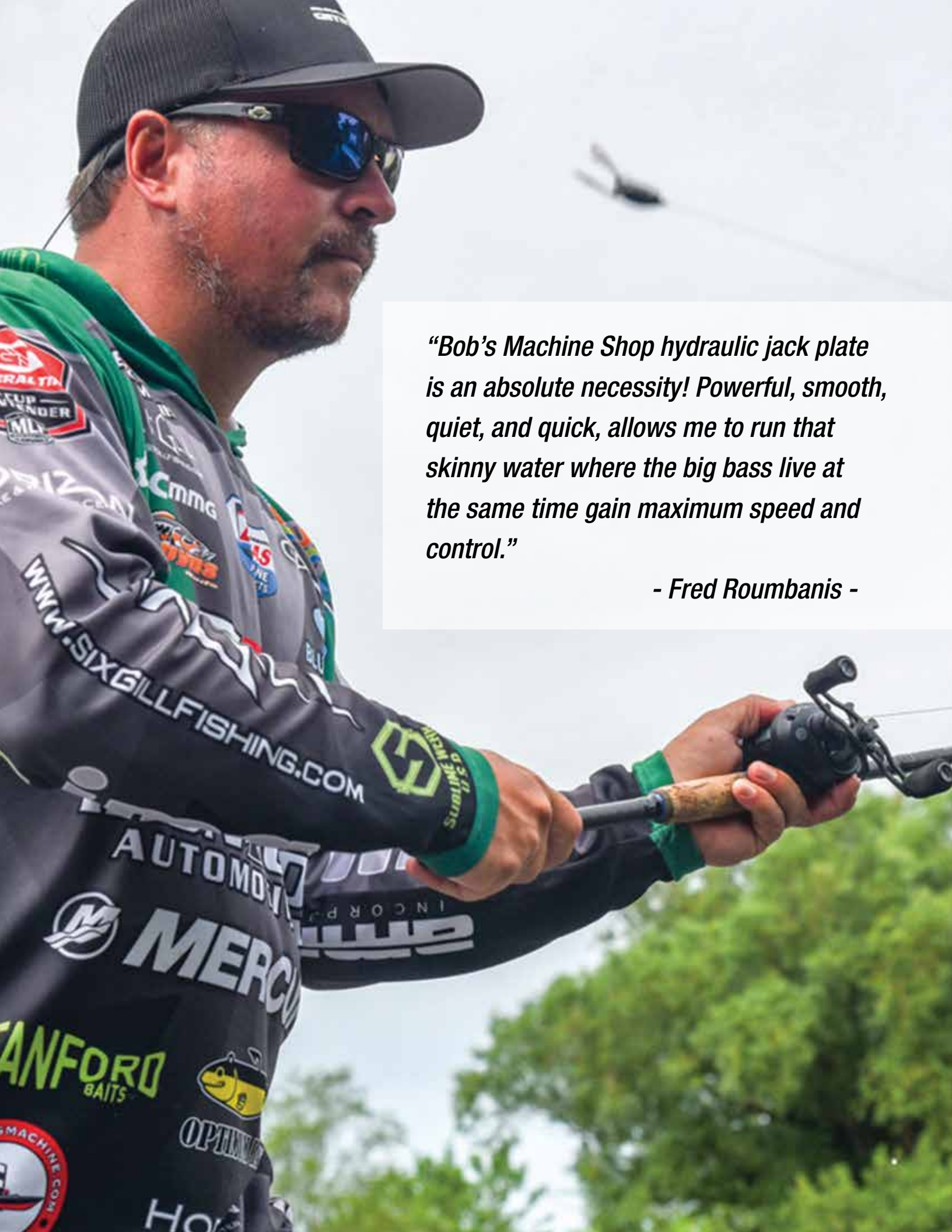

“Bob’s Machine Shop hydraulic jack plate is an absolute necessity! Powerful, smooth, quiet, and quick, allows me to run that skinny water where the big bass live at the same time gain maximum speed and control.”

- Fred Roumbanis -



TROLLING MOTOR ACCESSORIES

**THE
BIG**

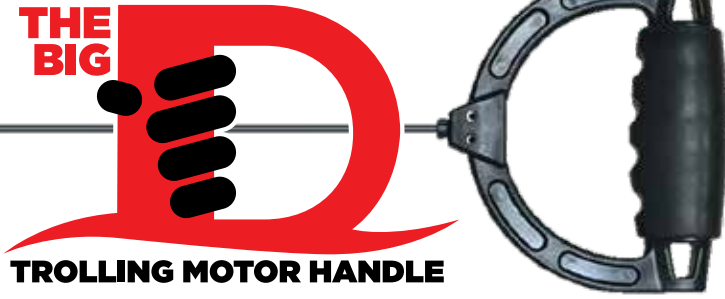

TROLLING MOTOR HANDLE

TROLLING MOTOR HANDLE

- Patented design with the cable molded into the handle so it will not break out.
- Designed for big hands, comfort and reliability
- Stainless steel vinyl coated cable
- Stainless steel cable clamp included
- Works on most MinnKota™ and Motorguide trolling motors
- Fits the Lowrance Ghost trolling motors

315-200000



CHECK OUT THE VIDEOS AT:

THEBIGDHANDLE.COM

BOB'S TROLLING MOTOR PROP NUT

- Fits all Motorguide, Minnkota, Lowrance, and Garmin trolling motors
- Requires no tools to remove trolling motor propeller
- Over 25% more mass than other units on the market which means quieter trolling!
- Center hole to access shaft in event of shear-pin failure
- Ultimate Coating that will not fade and superior corrosion resistance!



Standard Color: Ultimate Black

#312-000000 - Minnkota (80+ lbs)

#312-100000 - Minnkota (70- lbs)

#312-200000 - Motorguide (All)

#312-300000 - Lowrance Ghost (All)

Change the last number to order any of these colors:

- 1 - Gloss Black, 2 - White, 3 - Red, 4 - Blue,
5 - Green, 6 - Orange, 7 - Brushed Aluminum,
8 - Carbon Fiber



TROLLING MOTOR ACCESSORIES

BobsMachine.com

813.247.7040

Quick-Slip

QUICK SLIP CAM LEVER FOR TROLLING MOTORS AND RAM® MOUNTS

- Makes adjustments quick and easy with a flick of a lever
- Make height adjustments much quicker and securely
- More pressure than the standard knob
- Holds even the largest GPS units tightly
- Simple 1-minute installation

#160-200000 - Freshwater Pro

#160-200001 - Freshwater Tour

#160-200002 - Wireless Series

#160-200003 - Gatormount/Great white

#160-200004 - Motor Guide X3 & X5

Minnkota Trolling Motors

#160-300000 - Maxxium/Fortrex 2003 and earlier

#160-300001 - Maxxium/Fortrex 2004 and newer

#160-300002 - Terraova

#160-300004 - Edge

#160-300005 - PowerDrive

#160-300006 - Ultrex

#160-400000 - Ghost

Ram Mount

#160-100000 - Big Ball

#160-100001 - Medium Ball



*Snap the QR code, for
Quickslip video*

DECKSAVER



PROTECT YOUR DECK WITH DECKSAVER!

CNC'd Billet Aluminum, coated for long life. Simple one-screw installation. Available in Brushed Aluminum, Red, Blue, Green, Black, and White. #311-100000

Standard color is Brushed Aluminum. Order one of these colors by changing the last number of the part number-

1 - White, 2 - Red, 3 - Orange, 4 - Green, 5 - Black, 6 - Blue



TROLLING MOTOR ACCESSORIES

BobsMachine.com
813.247.7040

37

DECK PLUGS

DECKPLUGS



DECK PLUGS

BobsMachine.com
813.247.7040



Bob's Machine's new patent pending O-ring sealed pedestal seat plugs close the hole on your deck when your pedestal seat is not in use. Keep your compartments water tight to prevent mildew, and stop loosing baits/weights/hooks down the holes. Also adds some bling to the deck of your boat!

#311-000001 - 1.77" Deckplug

#311-000002 - 0.75" Deckplug

#311-000003 - 2.38" Deckplug

Standard color is Brushed Aluminum. Order one of these colors by adding this code to the part number-

B - Blue, BK - Black, C - Carbon, G - Green,
O - Orange, R - Red, W - White





5/8" SPACERS
#401-058000



3/4" SPACERS
#401-075000



1" SPACERS
#401-100000
(Necessary for Yamaha 425 HP to
mount to the Extreme jack plate)



**2" SET BACK SPACERS
WITH 4.5" BOLT KIT**
#401-200000

2 INCH SET BACK SPACERS

These spacers are made out of strong aluminum alloy and machined flat on both sides. Adding these spacers is the simplest way of getting that extra mph. These spacers go between the transom and the engine's mounting bracket. In some cases they can also be installed between the jack plate and engine. By applying the set back spacers to the transom, you are moving the center of gravity of the hull further back. By doing this you are rebalancing the boat which allows the hull to remain at its present attitude with less trim. Therefore, you have more power to push the boat forward rather than to hold the bow up. The kit comes complete with stainless steel bolts and nuts.

SOLID MOTOR MOUNTS



Bob's Solid Motor Mounts have the rigidity you need to assure precise steering at high speeds. They eliminate propeller fishtailing permitted by flexible mounts. Even so called "high performance" pinned or hard rubber mounts aren't as rigid as you deserve for high-speed handling ease and safety, so don't settle for less than Fixed Motor Mounts. They're like trading in sloppy linkage and getting rack and pinion steering in return. Your boat will steer more reliably throughout its entire speed range in both the smoothest and the roughest water. The hull's more consistent relationship to the water enables you to run safely at higher speeds than possible with conventional "rubber band" mounts. Fix your steering now with Bob's Fixed Motor Mounts! Each set contains 2 upper and 2 lower mounts.

- #404-100000 - Mercury® V6
- #404-000000 - Mercury® 3 Liter
- #404-200000 - Mercury® Inline
- #404-360000 - Yamaha V4 and 2.6L V6
- #404-331000 - Yamaha 3.1L and 3.3L
- #404-500000 - Yamaha SHO 4.2L
- #404-363000 - 2 stroke V6 Suzuki mounts
- #404-400000 - 4 stroke V6 Suzuki mounts



SIDE SPACER

FOR POWER POLES, TALONS AND RAPTORS

- #401-075002 - 2" Side Spacer
- #401-075001 - 3/4" Side Spacer

2 INCH OFFSET SPACER

For 600HP Mercury

- #401-200001

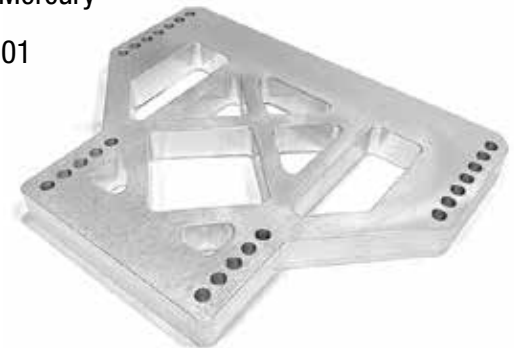

TRANSOM WEDGES

BMS TRANSOM WEDGES

Bob's Machine Shop's new transom wedges, are stronger than ever before. Offering 2, 5, and 10 degrees of either negative or positive trim, these wedges are great for any application, including the Yamaha F350. These 1", 2, 5, and 10-degree cast aluminum wedges are used as an aid for boats with an insufficient transom angle or for boats having planing problems at low speed. Fits all motors with BIA bolt patterns. Custom powder coating available.

#319-300000 - 10 Degree

#319-200000 - 5 Degree

#319-100001 - 2 Degree



WEDGE WASHERS

Use these Wedge Washers on outside of the motor, the nuts lie flat when using wedges.

5 degree washers shown

#319-400102 - 10 Degree

#319-400102 - 5 Degree

#319-400102 - 2 Degree



TRANSOM WEDGES

BobsMachine.com
813.247.7040

BIGFOOT NOSE CONE KITS



- 50% more cooling capacity
- Higher speed & proper water pressure
- Low water pick-up
- 50% more volume than any now on the market
- Nose cone kit contains all hardware for complete installation
- Kit comes with complete almag-35 top grade casting, epoxy kit, hose fittings, 8" of rubber hose and installation instructions.

SHALLOW WATER ACCESS

Travel and fish waters that until now have been unreachable with outboard motors having standard (side water pick-up) gear cases.

PROVEN QUALITY

The same superior design as our world speed record holding Big Foot, low water pick-up cones.

- Crescent-shape for superior performance & handling
- Five inlets create less chance of stoppage than anything now on the market

HIGH WATER FLOW CAPACITY

Allows surface piercing props (choppers, cleaver-style) to be run at maximum height for top speed and all out performance, while maintaining proper cooling to engine.

FACTORY INSTALLATION AVAILABLE

Only manufacturer to offer complete factory installation, usually completed within 10 working days from delivery date. Call for details. Over 30,000 cones installed in the past 5 years!

NOSE CONES TESTED	TOP SPEED MPH MAINTAINING TOPSI	MAX MOTOR HEIGHT ABOVE TRANSOM WHILE WHITHOUT PROP SLIPPAGE WATER PRESSURE MIN	RPM OBTAINED
Bob's	74.8	Sky High	6250
Hydro Motive	72.5	3-1/2"	6150
Land & Sea	70.1	2-1/4"	5850
Mercury® Stock	69.7	2-1/2"	5900
Mercury® CLE (Racing)	68.5	No Limit	6150

TEST BOAT AND EQUIPMENT USED

Boat: Nitro 190TF (19' bass boat)

Motor: Mercury® 150 XRI, 150 HP

Gearcase: 1:87:1 Ratio

Load: two 200-pound men; 28 gallons of fuel, rear livewell half-full

Prop: Quicksilver trophy, four blade, small hub, 13-3/8 x 25 inch pitch

Speed: Radar checked

Conditions: Test held in under four hours with conditions at the start virtually the same as at the end. Flat to 2" chop, no wind, 58 degrees air temp.

FRESH WATER FLUSHING KIT

- Designed specifically for all Bobs nose cone kits with low water pick-up.
 - Can only be used on BOBS low water pick ups.
 - Attaches to garden hose.
 - Will not scratch or mar.
 - One-person operation
- #202-100000



EPOXY PUTTY

Two component liquid epoxy. Excellent glue for wood, fiberglass, styrofoam, concrete and metal surfaces. Dries tack free in 1 to 2 hours at 70°F, full cure 72 hours. Contains two 16 oz. (1 pint) cans. Included in every kit.

#202-200000



INCREASES SPEED, PERFORMANCE, HANDLING & ECONOMY

FACTORY INSTALLATION AVAILABLE

HIGH WATER FLOW CAPACITY

Allows surface piercing props (choppers, cleaver style) to be run at maximum height for top speed and all out performance, while maintaining proper cooling to engine.

PROVEN QUALITY

- The same superior design as our world speed record-holding Big Foot, low water pick-up cones.
- Crescent-shape for superior performance and handling.

SUPERIOR CASTING AND DESIGN QUALITY

- Over 15000 cones installed in the past 5 years.

50% MORE VOLUME!

Nose Cone Kit contains all hardware for complete installation. Pictured below are gear cases showing different type cones installed for a variety of applications. Please note: grass slippers are not available if you have a nose cone installed. Note: Most cones can be bought in kit form or professionally installed by Bob's Machine Shop.

NOSE CONE INSTALLATION INFO

Shown in these pictures is an example of factory installation. You can send unit completely assembled (any kind; Merc, Yamaha, Johnson, Evinrude, Mariner, etc.) Gears do not have to be removed, unless preferred. Units are UPS shippable. We need units for approximately 7 to 10 working days upon receiving unit. Upon arrival all gear cases are marked and dated with customer's ID# to ensure proper identity.

1. We sandblast the gearcase.
2. We will center-line nose cone to prop shaft, weld nose cone in place while being held in a fixture to ensure proper alignment.
3. We blend the nose cone into the unit using fiberglass fillers and finish to the proper contour and shape using air files, D.A. Grinders, etc.
4. We prepare the case to be painted with an etching primer and then a sealer primer and then to a finish paint.

5. We reassemble the unit putting stainless steel hoses on to the job and ship to customer (approximately 7 to 10 working days to ship).

Warranty: 2 years against blistering & bubbling

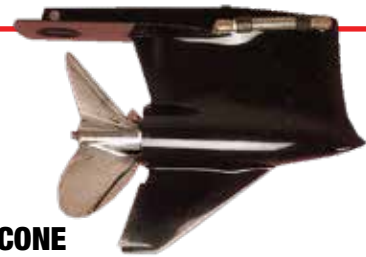

BIG FOOT CONE

Performance boats, race boats, etc. Designed for highest possible engine setting and maximum overall performance. #201-101100



COMBO CONE

Flats boats, bass boats, etc. Pickups on top and bottom of bullet (for sandy areas) #201-301100



THE SPORTSMAN'S EDITION

With water inlets located in five different locations (as shown) and a total of from 11 to 13 inlets - The most versatile low water pick-up nose cone available. #201-601100

BIGFOOT NOSE CONE KITS

BobsMachine.com
813.247.7040

MISCELLANEOUS COMPONENTS

MARINE FOOT THROTTLE

FOR OUTBOARD AND INBOARD ENGINE APPLICATIONS.

Fully CNC machined. Stronger, lighter, better looking. Available anodized either silver or black. Work with any motor. Universal fully machined aluminum foot throttle. #307-002100 - Anodized Blac



#307-900000 - Foot throttle replacement spring

OPTIONAL FOOT THROTTLE SLIDE PLATE

Slide plate allows foot throttle to be moved back and forward to match leg length of driver. For instance, if foot throttle is mounted permanently in the most forward position for a six foot driver, then someone 5'6" or 5'8" drives the boat, he or she can't comfortably reach the foot throttle without sitting on the edge of the seat, which is not only inconvenient, but also unsafe. Ceramic "Cerakote" available.

#307-000000



BLOW OUT RING

Blow out happens when the ratio of air to water surrounding the prop gets so great that the prop is no longer biting the water, in fact the prop is now trying to drive itself through air (or a relative vacuum). When blow out occurs, the prop will lose its bite in the water possibly causing a loose steering feeling or a violent right turn. The speed at which blow out can occur will vary depending on boat design, lower unit design, and prop design/pitch. A blow out ring helps to prevent this. Available for 2.0, 2.4, and 2.5 liter motors (not available for 3.0 liter).

#407-000000





#416-100000

Offshore:
#416-200000

ADJUSTABLE-HEIGHT TRANSOM MOUNTED WATER PICK-UPS

For outboards

- Adjustable height moveable pick-up tube. Allows exact setting for maximum results
- Square stainless steel pickup for maximum volume and durability
- Two models to choose from:
(Left) Offshore model for straight transom and tunnel type hulls
(Above) 90° model for boats which have a recessed pad or stepped-in pad, as on most bass boats, runabouts, ski boats, etc.



TORQUE TAMER

Bob's Torque Tamer will straighten out the high speed steering pull that today's high-pitched propellers produce when running at high transom settings. The paddle-wheel flow produced by the submerged part of such a propeller when much of the top half is out of the water swings your motor sideways (to starboard for right-hand drivers) harder the faster you go. If stock steering tabs have been reset in an attempt to compensate at high speeds – which they can't do – they will tend to swing the motor oppositely at lower speeds. Bob's Torque Tamer redirects high-speed flow so you don't have to fight it to steer where you want to go, and the stock tabs are readily trimmed at your lowest transom setting to keep you straight as intended at low speeds.

#409-100000 - Weld-on
#409-200000 - Rivet-on



SKEG REPLACEMENT

- Aluminum alloy
- Pre-shaping makes skag ready for heliarcing into place, thus eliminating delays of grinding and shaping
- Field-proven design brings 75% time-saving installation
- Broken skag? Whether your skag is chipped or entirely gone, now you have a choice! Use a skag replacement, not a new lower unit
- Installation available

#070-xxxxxx



ENGINE LOUVERS

Don't hold back on letting your engine perform at its best. Let your engine breathe at full throttle. Stock covers often restrict the air intake to the engine. With this kit installed your engine will have the breathing potential and looks of a factory race cover. Louvers are made of polished stainless steel and come with stainless screws, nuts and stainless rivets. Louvers available in two sizes.



LARGE: 3.25" x 9.75"

- | | |
|-------------------------|-----------------------|
| #415-000000 - Stainless | #415-000000D - Red |
| #415-000000A - White | #415-000000E - Blue |
| #415-000000B - Black | #415-000000F - Orange |
| #415-000000C - Green | |

SMALL: 3.25" x 3.25"

Can be used for ventilation on boat from engine cowlings, compartments, live wells, etc.

- | | |
|-------------------------|-----------------------|
| #415-000001 - Stainless | #415-000000D - Red |
| #415-000001A - White | #415-000000E - Blue |
| #415-000001B - Black | #415-000000F - Orange |
| #415-000001C - Green | |



OUTBOARD EXHAUST HOUSING

Exhaust Housing designed for Outboards Mercury® (2.0L, 2.4L, 2.5L only) O.M.C. (V4-V6 only) Yamaha (2.6 liter) Without modification to the engine, this simple, after-market add-on is designed to relieve back pressure on the engine and results in more efficient low-end throttle response, a better tuned engine and increased fuel economy.

- #403-210000 - Mercury® exhaust housing
- #403-220000 - OMC exhaust housing
- #403-230000 - Yamaha exhaust housing

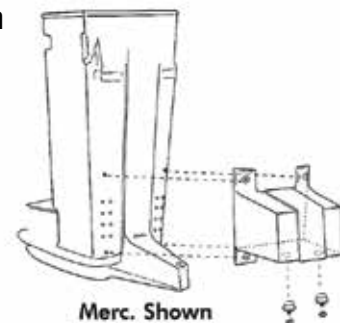

PERFORMANCE COMPONENTS

MERCURY® V-6 VELOCITY STACKS

(2.0L, 2.4L, 2.5L only) Increase air flow and performance. The air straightening effect created by the radius of the Venturi reduces turbulence (fogging) and improves air flow by approximately 10 CFM. Not available for 3 liter Mercury®. #412-000000



THE TUNER

(2.0L, 2.4L, 2.5L only) Constructed of a one-piece Almag casting and machined and drilled for application for the Mercury® V-6 engines, the tuner is designed to improve top end performance and allow your engine to breathe better, similar to what custom headers accomplish for an automobile engine. Not available for 3.0 Mercury®. #411-100000

YAMAHA TUNER

Fits all v76/carbureted/EFI/HPDI 3.1 and 3.3 liter Yamaha motors 1997 - present. #411-200000



STABILIZER PLATE

This new design of an already proven product gives all the advantages of the broad tail stabilizer plate (quicker hole shot, keeps boat on plane at lower speeds, increases top speed on most boats, smooths out the ride, helps stop porpoising), plus the new design has these added features:

- Boat has more stern lift
- Much less torque in steering wheel
- Flat-bottom boats steer better (less sliding)
- Most importantly, boat steers easier at low speeds with less correction of steering wheel (stops boat from wandering at low speeds)
- Available for most engines 75 horse power and up
- Custom colors available

#402-100000 - OMC/Pointed Cavitation plate

#402-060001 - 40HP and Up

For units between 25hp and 40 call for recommendations.

BOB'S HI-PERFORMANCE PLUG WIRES

FOR MERCURY® V4 AND V6, OMC V4, V6 AND V8

CALL US FOR CUSTOM WIRE SETS!

All spark plug connectors are 100% hi-temp, tight seal silicone boots with stainless steel non-corrosive snap-on units. Coil or distributor cap connectors are also 100% hi-temp silicone.

#414-260001 - 3.0L Mercury®

#414-260000 - Mercury® 2.0, 2.4 & 2.5L motors

#414-180000 - OMC V8 motors

#414-160000 - OMC V6 motors

#414-140000 - OMC V4 motors



PERFORMANCE COMPONENTS

BobsMachine.com
813.247.7040



THE ULTIMATE OIL SEPARATOR KIT FOR INBOARDS & TOW VEHICLES!

Developed to eliminate oil from entering your intake by engine blowby, which channels oil contaminated air into your intake, that reduces the octane of your fuel and causes detonation. Complete with AN fittings, Russel ProClassic hose, heat shrink, hose clamps, and Catch Can.

Cans are tapped with 3/8" NPT, so you can use your own fittings if ours aren't the right size. We use 5/8" Barb, or AN10 fittings/hose which fit MOST new cars and trucks, but simply measure your stock fittings to confirm.

Developed to eliminate oil from entering your intake by engine blow-by, which channels oil contaminated air into your intake.

A key problem caused by oil in the intake is that it reduces the octane of your fuel and causes detonation especially in turbo, supercharger and nitrous applications. Also larger amounts of blow by happen during towing, which further hurts your MPG.

Featuring a large chamber, and superior filtering media, this is the unit to have for your tow vehicle or performance engine. Draining the fluid is easy with a valve in the bottom.

USA made, with metal fittings, this unit is built to last.



Call for Part Numbers & options!

OILS & FLUIDS

LUCAS SAE 75W-90 M8 MARINE GEAR OIL

- Fortified with anti-foaming agents to prevent cavitation at high RPM's
- Safely blends with other gear oils/additives
- Protects against rust and moisture during long periods of storage

#120-301006 - Quart



LUCAS SYNTHETIC BLEND 2-CYCLE OIL

- Minimizes spark plug fouling
- Fortified with unique Lucas additives
- Specifically formulated for watercooled 2-cycle outboards and personal watercrafts

#120-301004 - Gallon

#120-301005 - Quart



JACK PLATE FLUID

- Lucas ISO 32 weight hydraulic fluid developed specifically for the Bob's Machine jack plate pumps.
- A completely empty system with standard hoses will use about 1.5 qts

#120-301003 - Quart



JACK PLATE GREASE CARTRIDGE

#120-302002

SEALANT

#920-920



TERMS AND CONDITIONS OF SALES

OFFICE HOURS: We are open from 8:00 a.m. to 5:00 p.m. Eastern Standard Time, Monday thru Friday.

TERMS: We accept most major credit cards, C.O.D. orders, as well as business checks for product plus freight. Shipping weights may vary due to dimensional shipping charges.

BAD CHECKS: There will be a \$30.00 charge for all checks returned to us unpaid by your bank. F.O.B.: All prices are net and f.o.b.

DELIVERY: Every attempt is made to ship all orders the same day they are received. Warehouse staff shall have the right to ship the fastest cheapest method possible. Unless otherwise noted UPS will be used within weight restrictions. Truck items over 150lbs. Single carton.

C.O.D. REFUSALS: \$5.00 charge, plus freight both ways, will be charged. Future service denied until these charges are cleared.

CLAIMS: According to the F.T.C. Title to merchandise passes to customer when shipper turns it over to common carrier. Any loss or damage in transit is the sole responsibility of the carrier. Make sure freight agent notes any shortage immediately and request inspection. We are more than willing to assist you in your claim, however, we are not responsible for collection of claims or replacement goods.

RETURNS: No returns accepted without prior consent. Merchandise must be shipped prepaid to RSM International, Inc., Inc. Returns made for reasons other than defective merchandise or RSM International, Inc., Inc. error will be charged a 15% handling charge.

NOTICE TO PURCHASER: The following is made in lieu of all warranties, expressed or implied. User shall determine the suitability of the product for his intended use and user assumes all risk and liability in connection therein. In no event shall RSM International, Inc., be responsible for damages or injury from any source whatsoever.

FOREIGN SHIPMENTS: Contact us for special shipping requirements. Prepayment is required.

PRICES: Subject to change without notice and those in effect at date of shipment will apply.

WARRANTY

RSM International, Inc., manufacturer, agrees to repair or replace any product or part thereof, of its manufacture when necessary as a result of defects in workmanship or material arising within one year from the date of purchase (6 months where noted with * unless otherwise noted). This applies only to the original purchaser and must be returned to the manufacturer prepaid, accompanied by the invoice or purchase ticket. This warranty shall not apply to any product or component thereof which has been repaired or altered outside the factory in any way so as, in the manufacturer's judgment, to affect its stability or reliability nor due to misuse, negligence or accident, nor shall the warranty apply to any product or manufacturer's printed instructions. In no event will RSM International, Inc., Inc. be liable for any incidental or consequential damages. This applies only to the replacement or repair of products manufactured by RSM International, Inc., and not to any replacement labor or expenses. All warranties are void on the following applications, conditions and installations: (1) Commercial Boats; (2) Competition Boats; (3) Improper installations; (4) Engine horse power exceeds the U.S. Coast Guard maximum horse power rating for the boat.

TECHNICAL SUPPORT DISCLAIMER

By using our web site, its information and any response to e mail questions you hereby agree to the terms of this site and any changes made to this disclaimer at any time. By entering this site, you hold this site and its affiliates not legally responsible for any damages due to advice given here, via e mail or via verbal response.

This site and its affiliates takes no responsibility for consequences of any actions that arise from advice given. Any technical information provided is for the personal non-commercial use and is for educational purposes only. It is not intended to be a representation or guarantee of any kind regarding any specific outboard or marine diagnosis or repair. Users of the technical information in this website will rely upon one's own independent analysis in making a diagnosis, modification or repair.

Any opinion is given with information provided by you and cannot be taken as absolute. All repairs and or modifications should be undertaken by a competent and qualified technician.

By using this site, you understand and agree that all advice given and followed are at your own risk and do not hold this site or its affiliates responsible for any damages. You further agree and acknowledge that your use is at your own risk and that none of the parties involved in creating, producing, or delivering this site, replying via e-mail or via verbal response is liable for any direct, incidental, consequential, indirect, or punitive damages, or any other losses, costs, or expenses or any kind (including legal fees, expert fees, or other disbursements) which may arise, directly or indirectly, through the access to, use of, or browsing of this site or through your downloading of any materials, data, text, images, video or audio from this site.

NOTE: Purchaser is not considered to be a "consumer" under the Magnuson-Moss Warranty Act, but shall be considered a merchant engaged in commerce.



"I've been using Bob's Machine Shop jack plates on my boats for over 25 years and have never been let down. When you're running hard from spot to spot it's the one jack plate you can consistently depend on to be successful."

- Scott Martin -

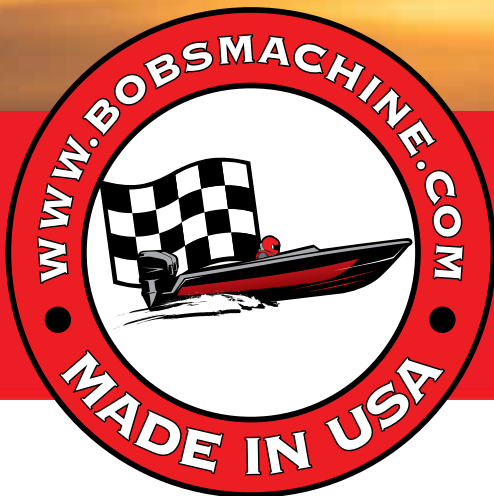

**2024
CATOLOG**

BobsMachine.com

ph: 813.247.7040

fax: 813.247.7041

email: Info@BobsMachine.com

***8802 E. Broadway Ave,
Tampa, FL 33619***

**MADE IN THE
USA** 